

RevNo	Revision note	Date
01	Drawing issued	.

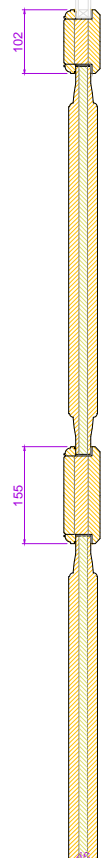

SECTION A-A

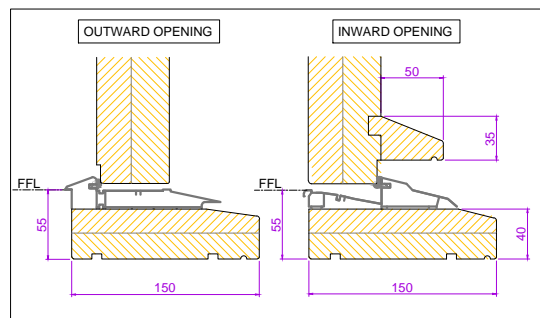
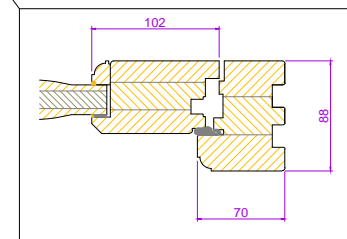
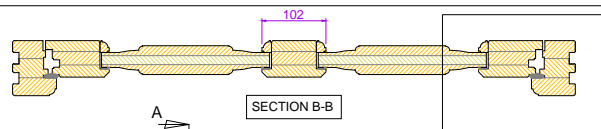
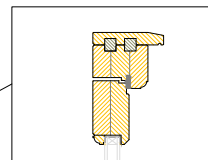
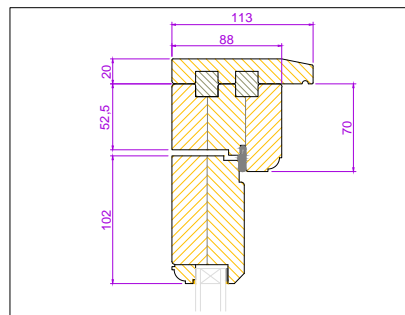
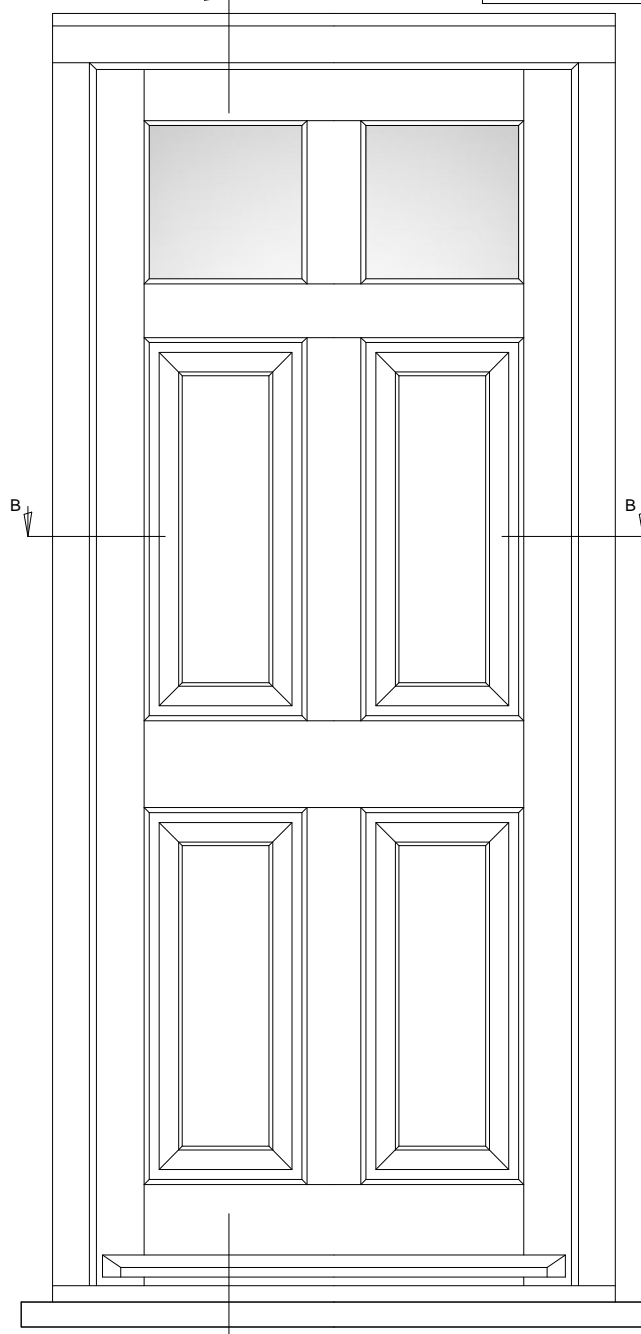
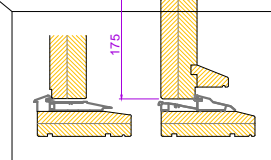

TRADITIONAL DOOR (AS VIEWED FROM OUTSIDE)

Project	
Title <b>ENTRANCE DOOR 018 PANELLED</b>	
Client	
Date	Scale DO NOT SCALE
	
<b>Fyntons</b> , Period Homes Supplies Centre Station Road, Nr Pampisford Cambridgeshire CB22 3HB Telephone 01223 837106 <a href="http://fyntons.co.uk">fyntons.co.uk</a>	
Drawing No.	<b>ED-P010</b>