

RevNo	Revision note	Date
01	Drawing issued	.

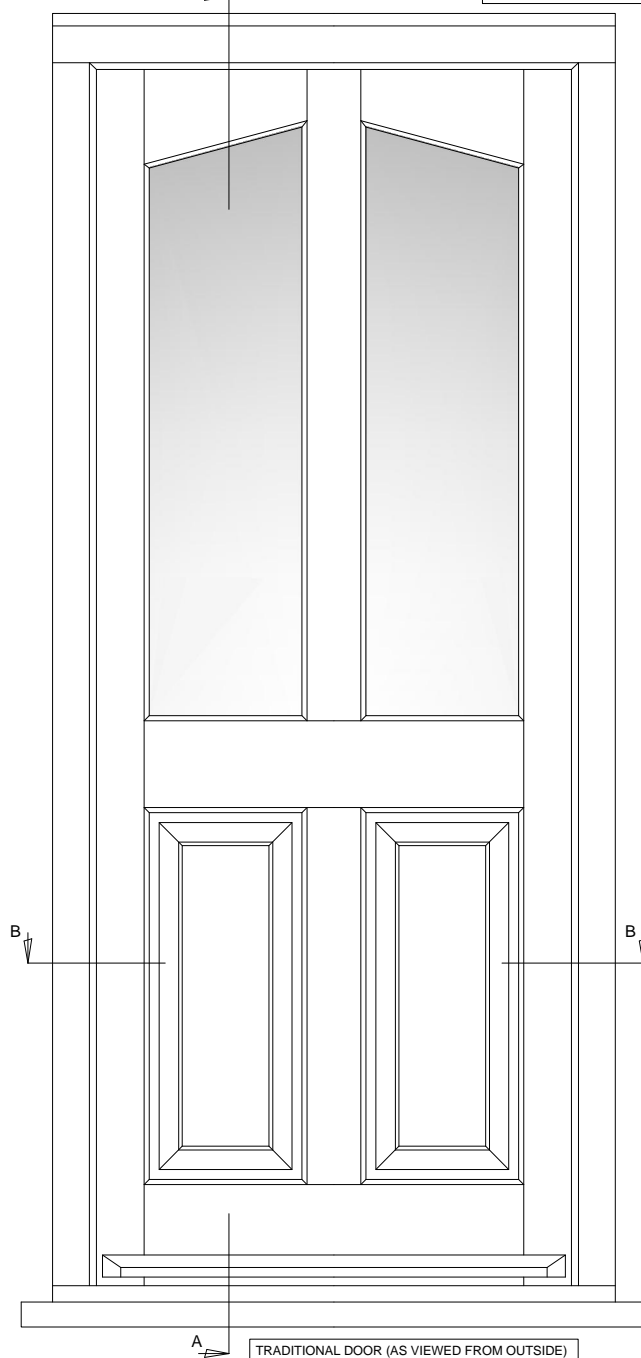
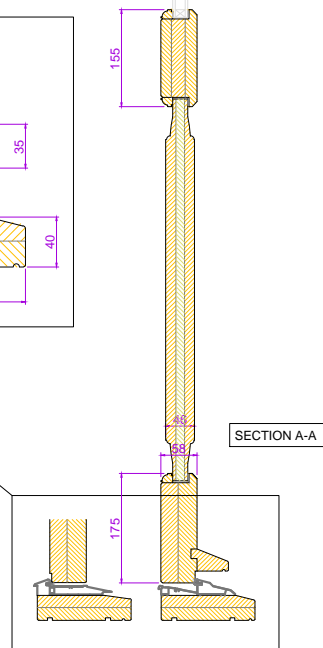
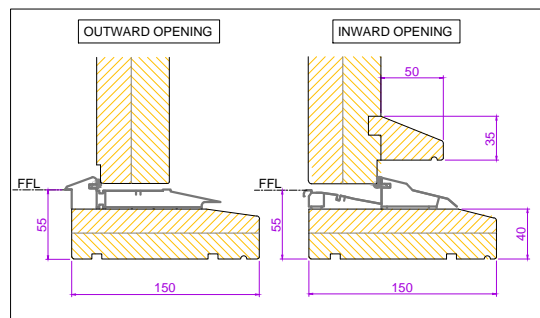
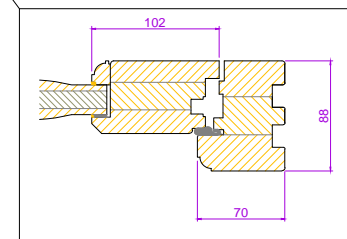
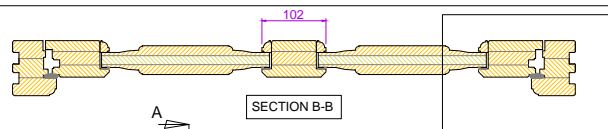
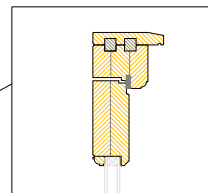
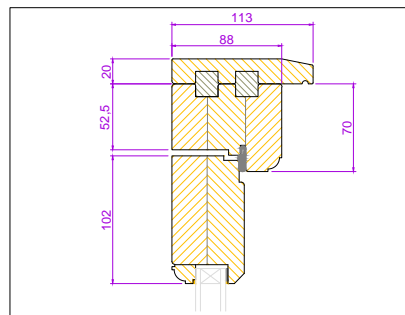

Project		
Title	<b>ENTRANCE DOOR 018 PANELLED</b>	
Client		
Date	...	Scale DO NOT SCALE
		
<b>Fyntons</b> , Period Homes Supplies Centre Station Road, Nr Pampisford Cambridgeshire CB22 3HB Telephone 01223 837106 <a href="http://fyntons.co.uk">fyntons.co.uk</a>		
Drawing No.	<b>ED-P013</b>	