

RevNo	Revision note	Date
01	Drawing issued	.

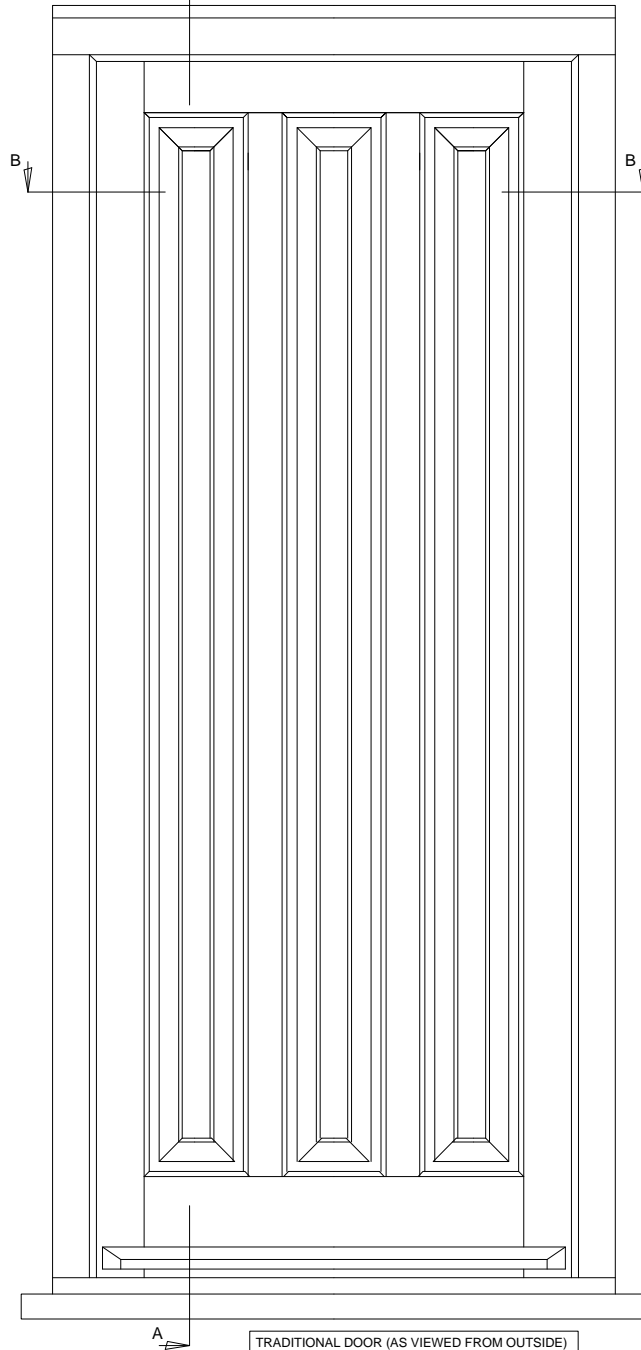
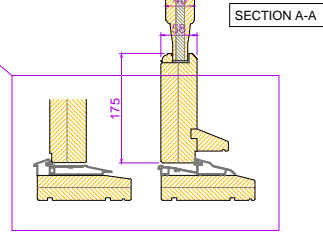
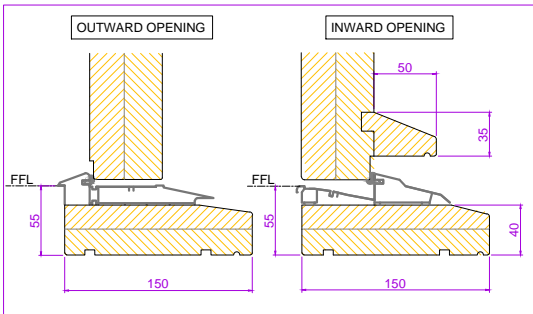
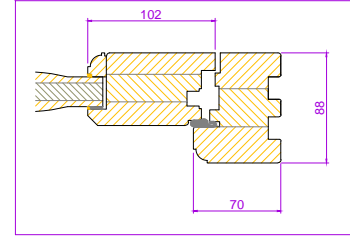
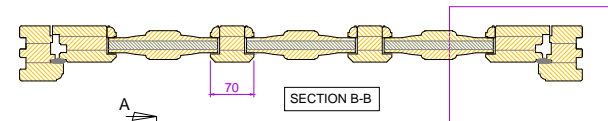
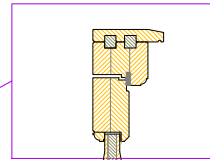
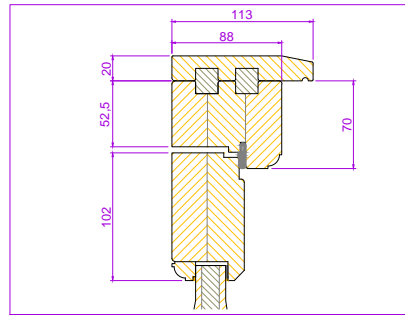

Project	
Title ENTRANCE DOOR 018 PANELLED	
Client	
Date	Scale DO NOT SCALE
	
Fyntons , Period Homes Supplies Centre Station Road, Nr Pampisford Cambridgeshire CB22 3HB Telephone 01223 837106 fyntons.co.uk	
Drawing No.	ED-P014